

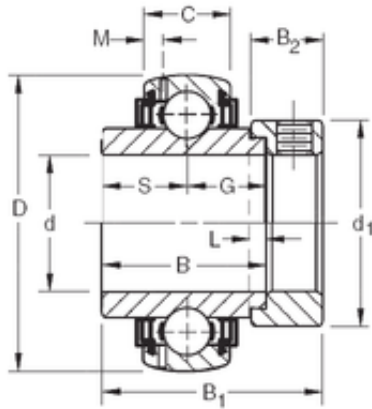

NACHI DRIVESHAFT, INC.

28,575 mm x 72 mm x 36,51 mm Timken GN102KLLB Ball Insert Bearings



Bearing No. GN102KLLB

Size	28.575x72x36.51 mm
Bore Diameter	28,575 mm
Outer Diameter	72 mm
Width	36,51 mm
d	28,575 mm
D	72 mm
B	36,51 mm
C	20 mm
d1	49,21 mm
B1	1,97 mm
B2	17,46 mm
G	19,05 mm
L	3,9 mm
M	3,61 mm
S	17,46 mm
Weight	0,554 Kg
Basic dynamic load rating (C)	33,5 kN

GN102KLLB Bearing 2D drawings and 3D CAD models